

LED Multi Watt Multi CCT Back Lit Panel with Emergency Battery

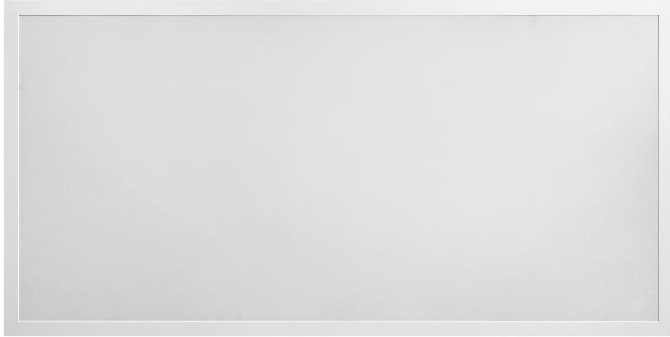

2x4

29W, 34W, 39W and 49W



2x2

15W, 19W, 24W and 29W

FEATURES

- Default Wattage is the highest wattage
 - 2x4 – 49W
 - 2x2 – 29W
- Default CCT: 5,000K
- 15W Emergency battery included
- IP20 rating – dry location
- Glare-free / flicker-free lighting
- 100,000 hours lifetime

SUITABLE APPLICATIONS

- Warehouses
- Schools
- Factories
- Offices
- Supermarkets
- Logistic Centers
- Exhibition Halls

CONSTRUCTION:

Steel and Aluminum frame. PMMA lens material to prevent panel from yellowing. The entire fixture functions as a heat sink to keep the LEDs cooler to prolong the life of the light.

OPTICAL SYSTEM:

Lumiled 2835 LED chips. 120° beam angle.

WARRANTY:

5-year limited warranty. Actual performance may differ as a result of end-user environment and application.

ELECTRICAL:

120-277V input standard.
-20°C to 50°C, -4°F to 122°F

INSTALLATION & MOUNTING:

Fits standard T-bar and narrow grid drop ceilings.
Surface mount kit, recessed kit or hanging kit.

CONTROLS & DIMMING:

0-10V dimming comes standard. Suitable for use with LED dimmers.



MODEL NUMBER – 3,500K, 4,000K and 5,000K	SIZE	WATTAGE	LUMENS	EFFICACY	CRI	POWER FACTOR	THD	REPLACES
LOC-22BLPL-MWMCCT-HL-EM	2x2	15W	1,898.55LM	126.57LM/W	83.1	0.9797	10.83%	150W HID
LOC-22BLPL-MWMCCT-HL-EM	2x2	19W	2,404.83LM	126.57LM/W				150W HID
LOC-22BLPL-MWMCCT-HL-EM	2x2	24W	3,037.68LM	126.57LM/W				150W HID
LOC-22BLPL-MWMCCT-HL-EM	2x2	29W	3,699.5LM	126.57LM/W				150W HID
LOC-24BLPL-MWMCCT-HL-EM	2x4	29W	3,819.88LM	131.72LM/W	84.1	0.9477	8.24%	200W HID
LOC-24BLPL-MWMCCT-HL-EM	2x4	34W	4,478.48LM	131.72LM/W				200W HID
LOC-24BLPL-MWMCCT-HL-EM	2x4	39W	5,137.08LM	131.72LM/W				200W HID
LOC-24BLPL-MWMCCT-HL-EM	2x4	49W	6,450.5LM	131.72LM/W				200W HID

Series	Size	2x2 Wattage	2x4 Wattage	Color Temperature	Type	Accessory
LOC-BLPL	22 = 2x2 24 = 2x4	15W 19W 24W 29W	29W 34W 39W 49W	3500K 4000K 5000K	HL = High Lumen	EM = emergency backup

MEASUREMENTS

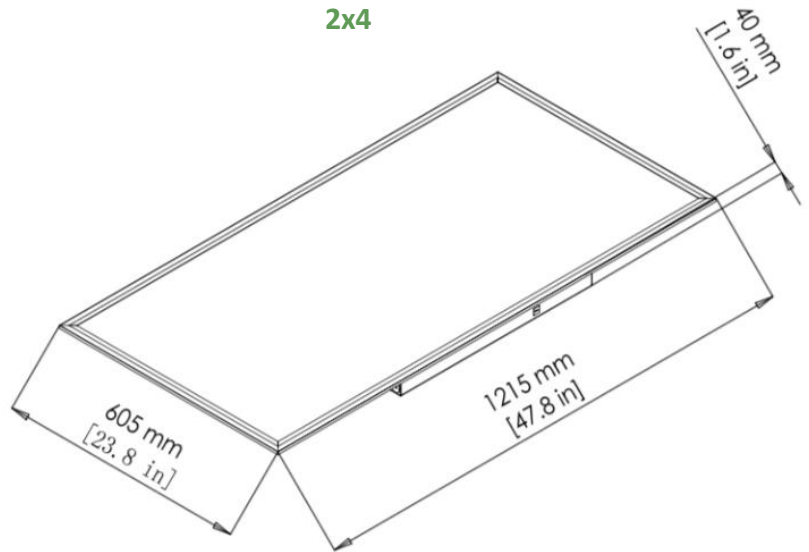
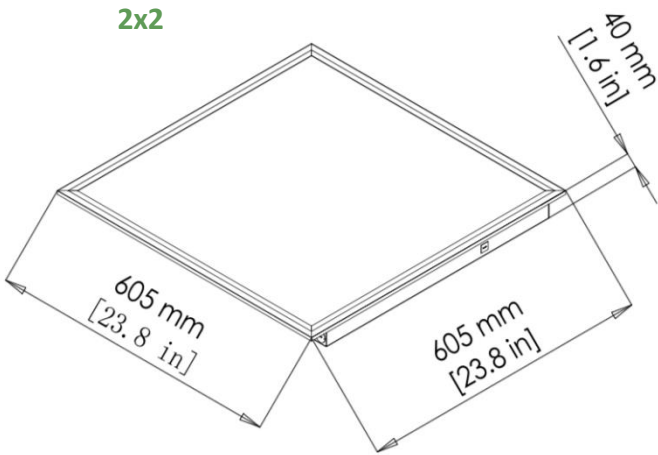

MODEL	QUANTITY	WEIGHT	UPC CODE
LOC-22BLPL-MWMCCT-HL-EM	1		00810050940733
LOC-24BLPL-MWMCCT-HL-EM	1		00810050940702

15W Emergency Battery



Emergency Test Button



2x2 15W

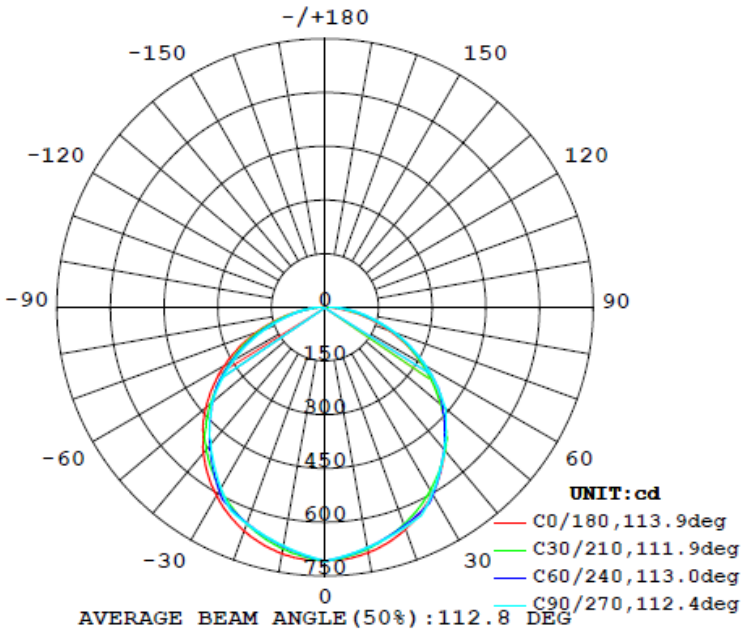

Flux out: 1471 lm

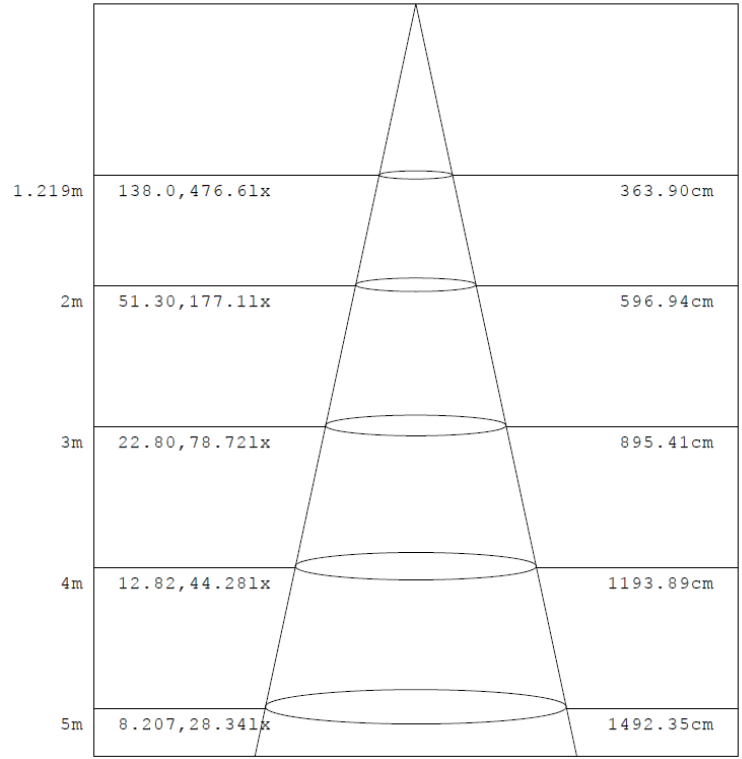

Note: The Curves indicate the illuminated area and the average illumination when the luminaire is at different distance.

2x2 19W

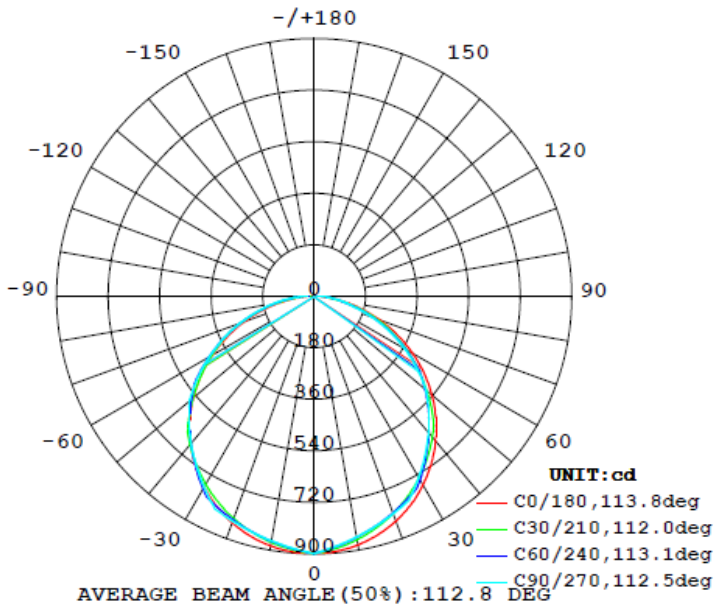

Flux out: 1866 lm

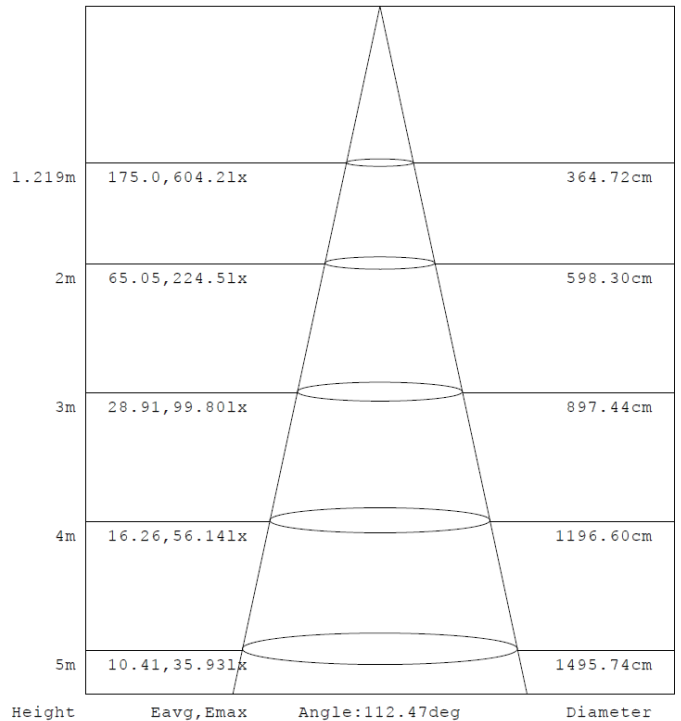

Note: The Curves indicate the illuminated area and the average illumination when the luminaire is at different distance.

2x2 24W

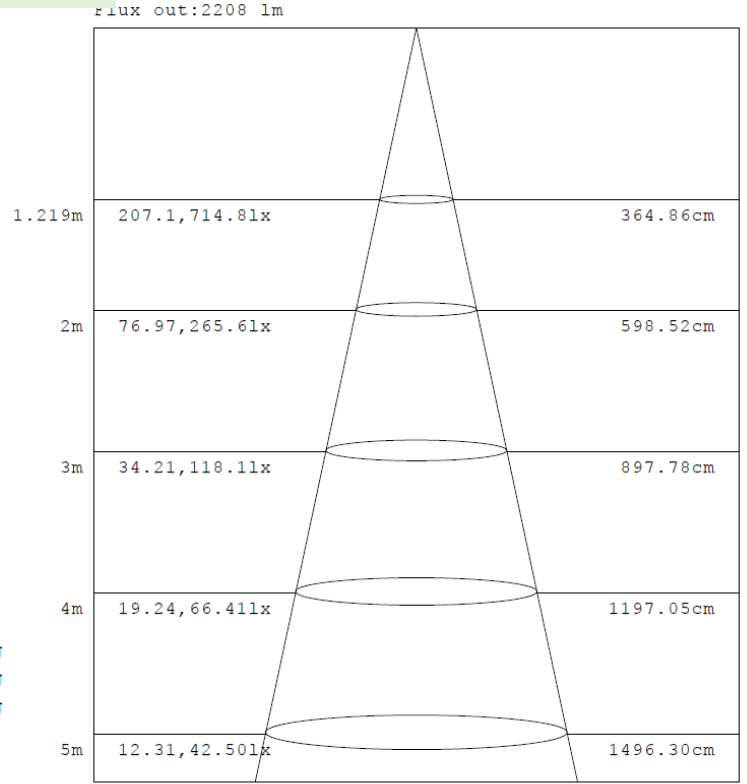
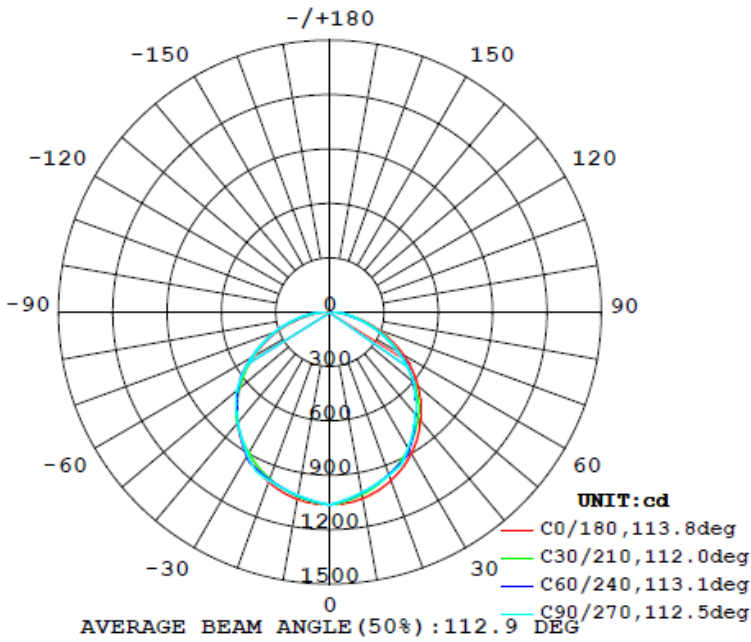

Note: The Curves indicate the illuminated area and the average illumination when the luminaire is at different distance.

2x2 29W

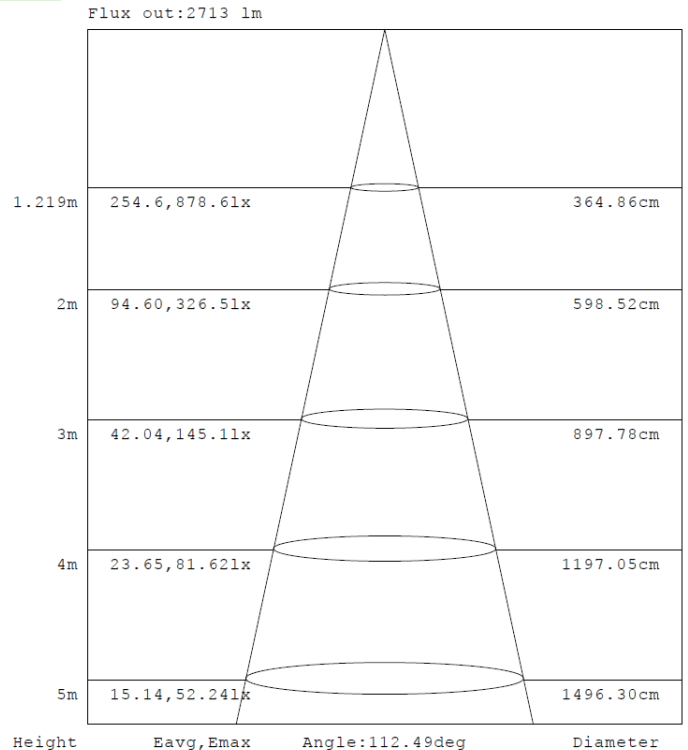
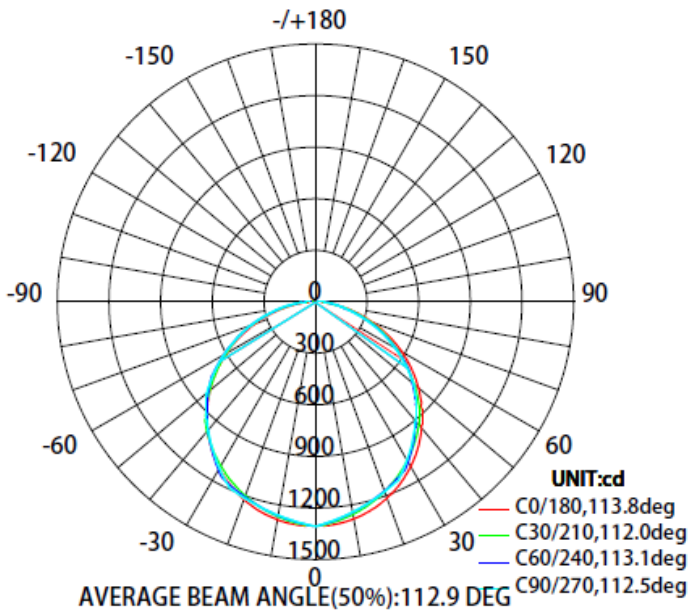

Note: The Curves indicate the illuminated area and the average illumination when the luminaire is at different distance.

PHOTOMETRIC DATA

2x4 29W

Flux out: 2911 lm

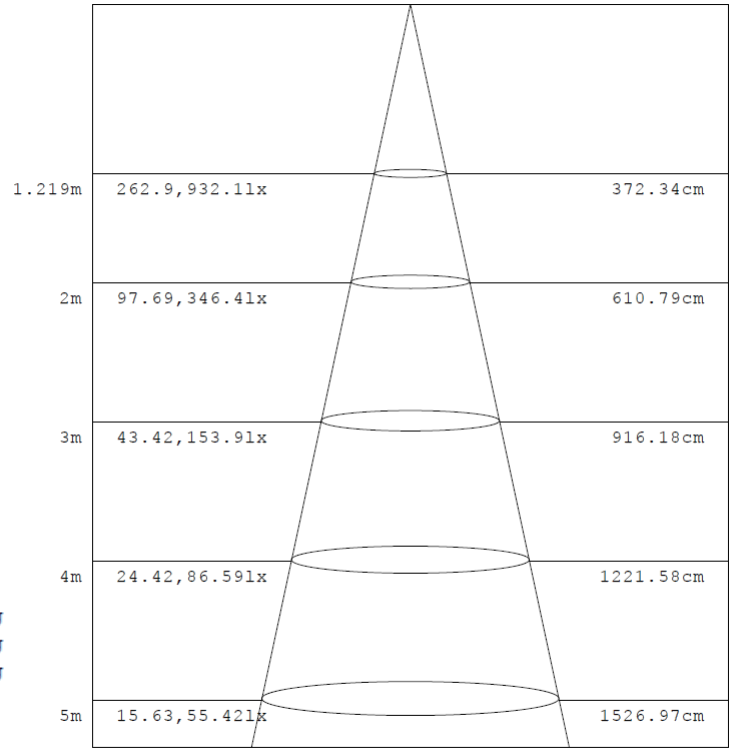
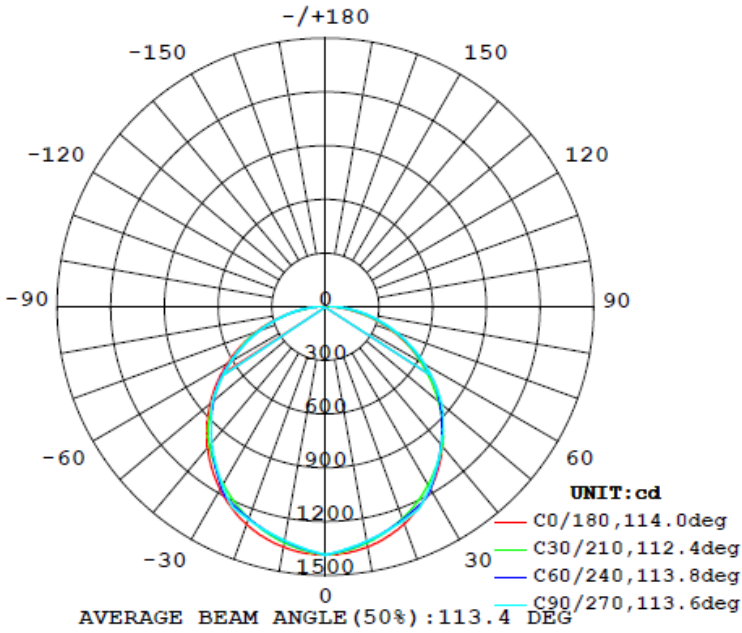

Note: The Curves indicate the illuminated area and the average illumination when the luminaire is at different distance.

2x4 34W

Flux out: 3288 lm

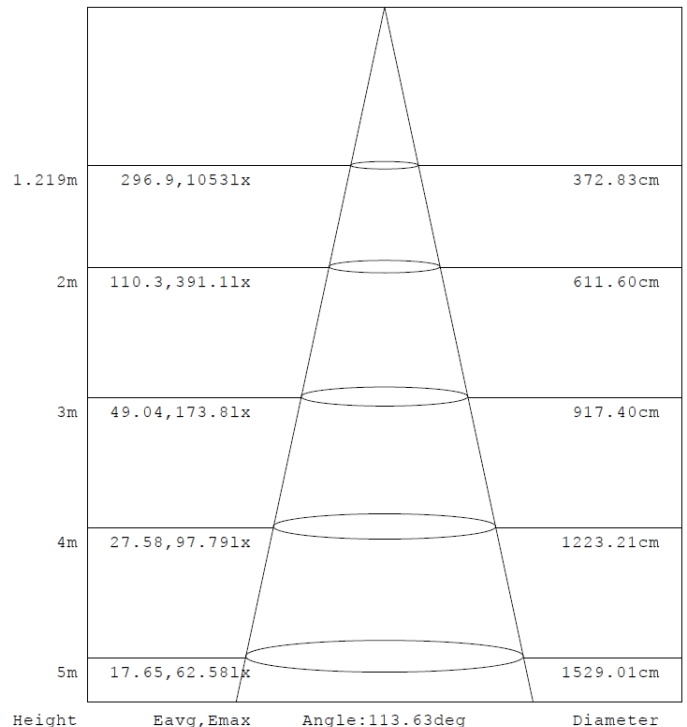
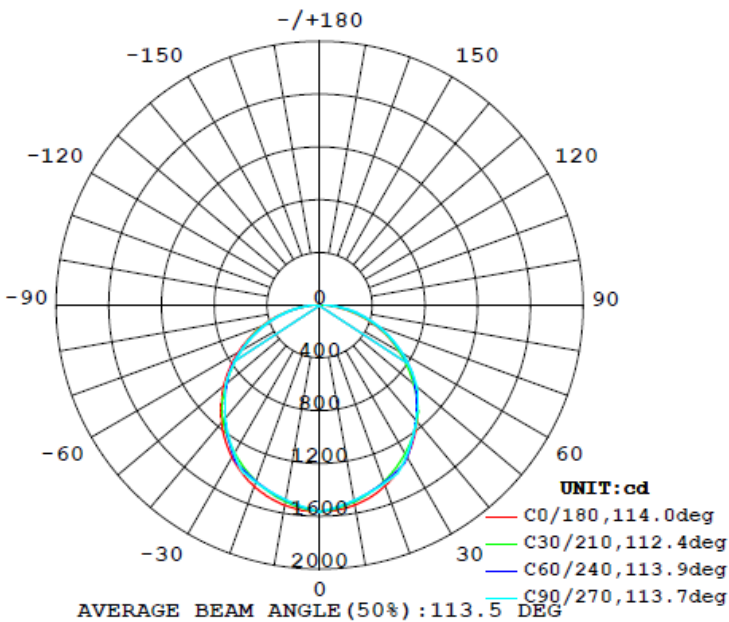

Note: The Curves indicate the illuminated area and the average illumination when the luminaire is at different distance.

PHOTOMETRIC DATA

2x4 39W

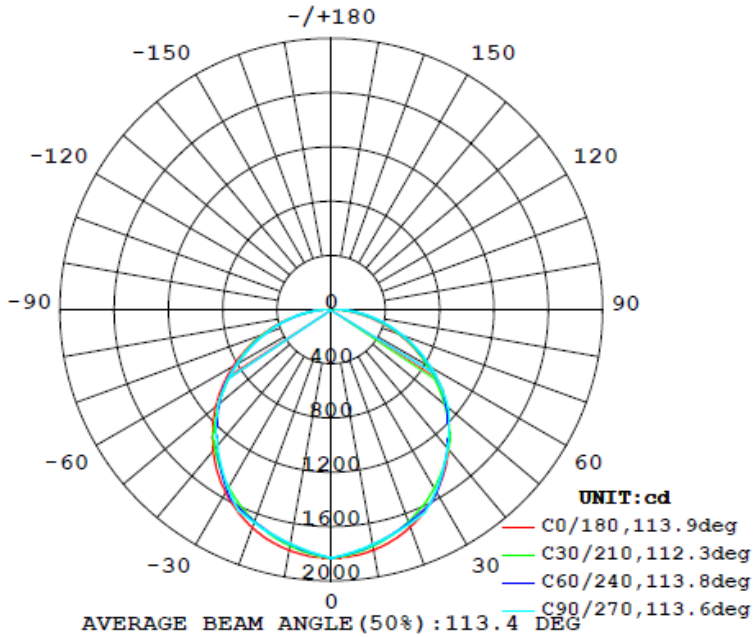

Flux out: 3848 lm

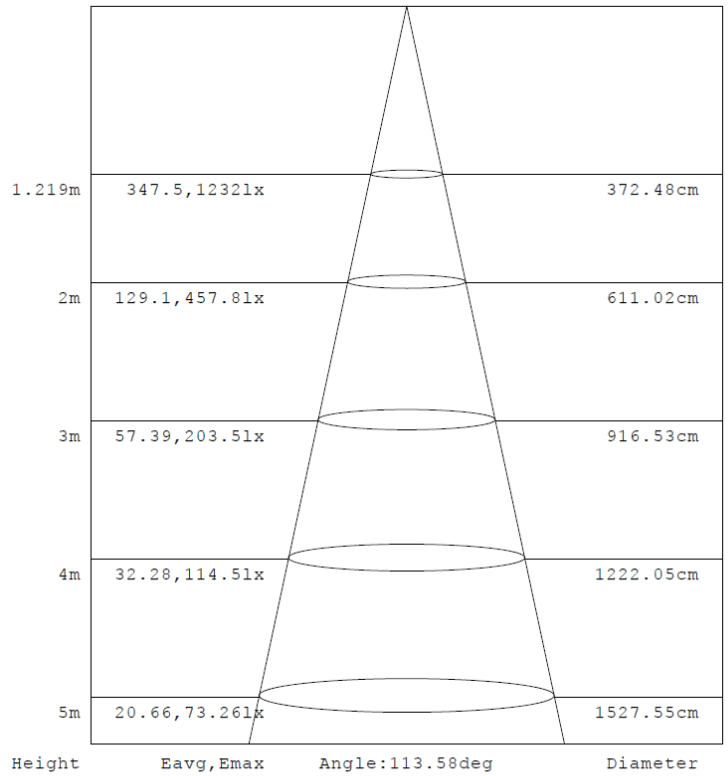

Note: The Curves indicate the illuminated area and the average illumination when the luminaire is at different distance.

2x4 49W

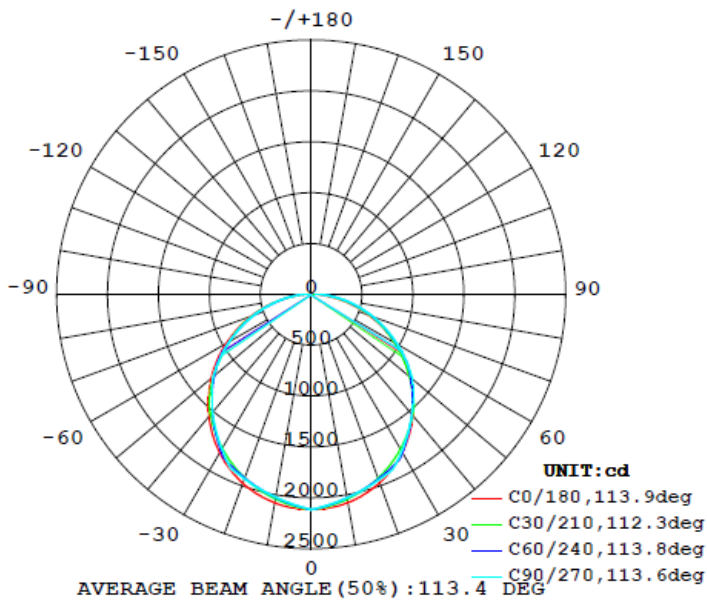

Flux out: 4442 lm

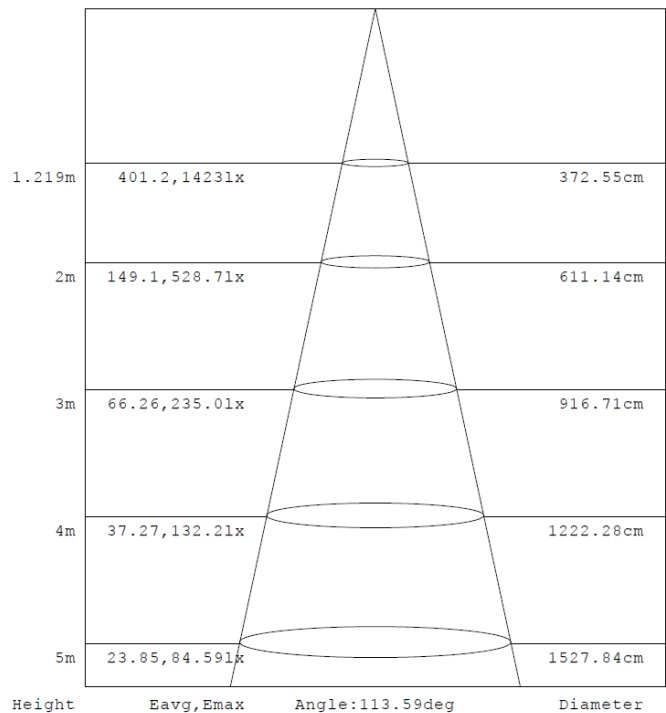

Note: The Curves indicate the illuminated area and the average illumination when the luminaire is at different distance.

MOUNTING OPTIONS

Surface Mount

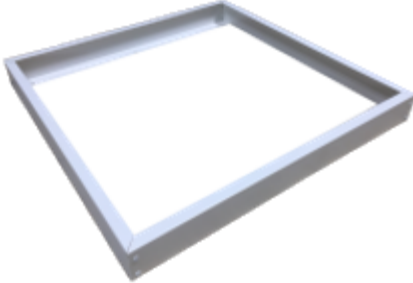

Recessed Mount



Hanging Kit

